

Item number	Productcode	Power	Light colour Ledxon	CRI	Luminous flux	Beam characteristic	Length	Weight
9100949	SCL-G2-L900-940-FM-ASYM-BT	13,2 W	4000 K - Fresh meat	94	1250 lm	Handrail / Counter asymmetrical / Shelf edge / asymmetrical	906 mm	0,36 kg
9100950	SCL-G2-L1200-940-FM-ASYM-BT	18 W	4000 K - Fresh meat	94	1700 lm	Handrail / Counter asymmetrical / Shelf edge / asymmetrical	1212 mm	0,47 kg
9100954	SCL-G2-L900-927-957-ASYM-BT	13,2 W	2700 K - 5700 K	94	1300 lm	Handrail / Counter asymmetrical / Shelf edge / asymmetrical	906 mm	0,36 kg
9100955	SCL-G2-L1200-927-957-ASYM-BT	18 W	2700 K - 5700 K	94	1800 lm	Handrail / Counter asymmetrical / Shelf edge / asymmetrical	1212 mm	0,47 kg

ACCESSORIES

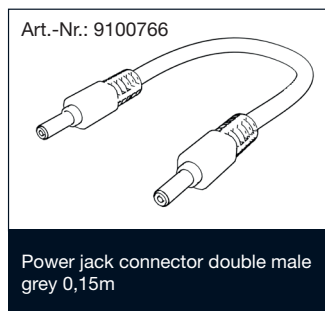
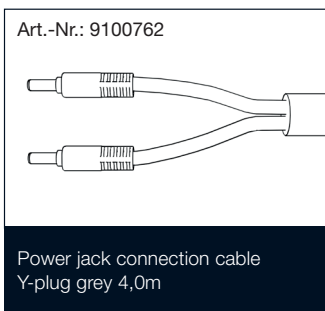
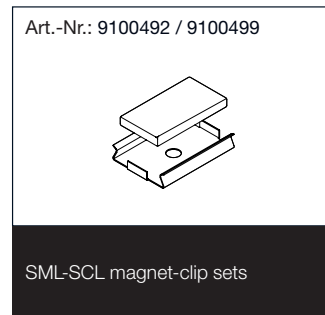
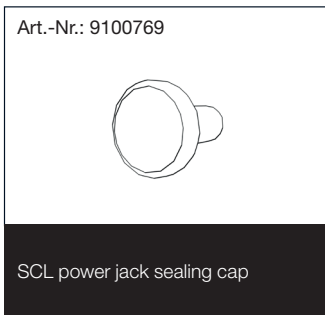
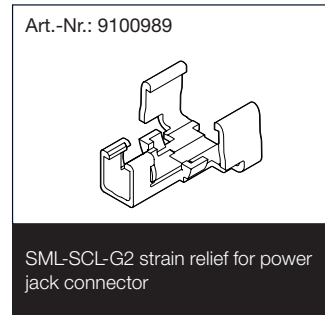
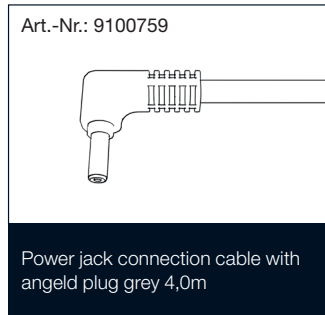
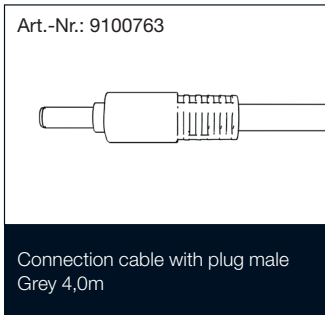

itembezeichnung	Item number
Connection cable with plug male grey 4,0m (for LCR-SCL-SML)	9100763
Power jack connection cable with angled plug grey 4,0m (for LCR-SCL-SML)	9100759
Power jack connection cable female grey 4,0m (for LCR-SCL-SML)	9100764
Power jack connector double male grey 0,15m (for LCR-SCL-SML)	9100766
Power jack connection cable Y-plug grey 4,0m (for LCR-SCL-SML)	9100762
Power jack end cap grey (for LCR-SCL-SML)	9100769
SML-SCL-G2 strip connector	9100791
SML-SCL clip adjustable set of 2 / 0-90° (for L450, L600, L900, L1200)	9100497
SML-SCL clip adjustable set of 3 / 0-90° (for L1500)	9100498
SML-SCL Magnet-Clip set of 2 (for L450, L600, L900, L1200)	9100492
SML-SCL Magnet-Clip set of 3 (for L1500)	9100499
Strip lock for connection cable male/female set of 2 (for LCR-SCL-SML)	9100780
SML-SCL-G2 strain relief for power jack connector	9100989

IMPORTANT NOTES

All technical parameters apply to the entire product. Due to the complex manufacturing process of light emitting diodes, the specified typical LED parameters are only purely statistical values and may deviate.

The specified type of use must be strictly adhered to. Deviations may affect the stability of the fixture. Please observe the information in the mounting instructions before using the products.

The specified type of use must be observed. Deviations may affect the stability of the fastening. Before using the products, please observe the notes in the installation instructions.

Mercury content	0,0 mg
Mercury-free	yes
Professional disposal according to WEEE	yes

NOTES TO THE LIFE TIME

Decisive factors for the life time are the ambient temperature and the operating temperature (Tc). Exceeding the permissible limits results in a substantial reduction of the life time and can even lead to the destruction of the products. The specified life time represents a statistical quantity.

NOTES TO ELECTRICAL AND PHOTOMETRIC DATA

Colour coordinates according to CIE 1931

Rated ambient temperature: $t_a = 25^\circ$

Measuring tolerance colour coordinates (x/y) +/- 0,005

Tolerance range of electrical / photometric data: +/- 10%

DISCLAIMER

Changes and errors excepted. Due to the continuous development of all products, technical and design changes can occur at any time. Make sure that you always use the latest version of the data sheet.

Further product data as well as current information can be found at www.lxpro.pl

5 YEARS
WARRANTY

